

**DOUGH DIVIDERS
AND ROUNDERS**

PRIMA

EVO



*Industrial power,
artisanal quality.*



TRIMA
TRY. TRUST. TRIMA.

**DOUGH DIVIDERS
AND ROUNDERS**

PRIMA

EVO



FUTURE version

perfect for..

Producing uniform, accurate weight and high quality round dough portions with precision programming of unit weight ranging from 15 g to 300 g. Ideal for many types of dough – soft, cool and sticky as well as firm and proven dough for uniform bread rolls with that artisan appeal. For making round and elongated bread rolls (kaiser rolls, hot-dog buns, hamburger buns, bolillo, berliner, pretzel etc.).

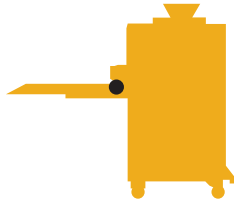

plus

9,000 pieces

The maximum quantity produced per hour with the 6-row operation (stepless reduction possible). Maximum 7,500 pcs/h at 5-row and 6,000 pcs/h at 4-row operation.

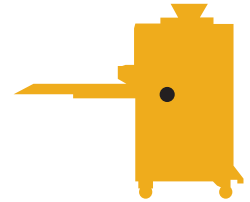

plus

Double-piston drum

Allowing a wide range of products of different weights to be produced without changing any mechanical parts - saving time and money.

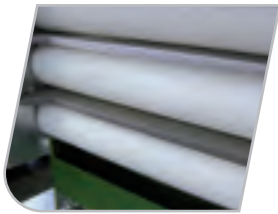

plus

Infeed rollers

To work all types of dough, the infeed rollers support the feeding of the dough. This does not stress the dough and reduces the use of flour. The flour reduction preventing the creation of holes in the dough which in turn avoids damaging the product.

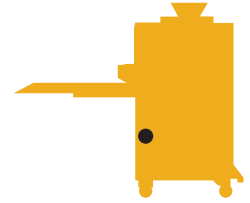

plus

Separate adjustment of moulding space

Regulating the space for rounding (regardless of piece weight), this ensures the dough is worked gently and its volume is not damaged. This method of working minimizes the amount of stress exerted on to the dough.

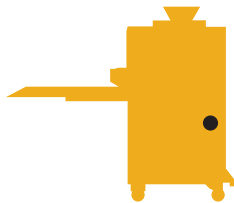
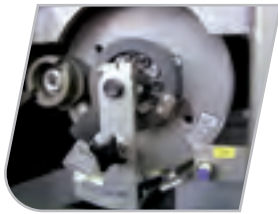

plus

Dough pressure adjustment

Depending on the type of dough (from low to high hydration), the pressure and also the amount can be regulated. An innovative system to stress the dough as little as possible in order to ensure optimal dough processing is achieved.

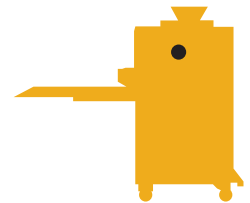

plus

Interactive Touch Screen

Available in Future version, for the electronic programming of all machine parameters (weight, moulding height, rounding speed, rounding time). Option of saving all the adjustments as a recipe and using them again.



plus

Easy cleaning

The hopper, pre-divider and moulder can be swivelled out of the machine - for perfect cleaning access.

No one else can offer you all this!

WEIGHT RANGES

Standard

15 - 55 g

20 - 70 g

30 - 85 g

35 - 90 g

40 - 100 g

45 - 110 g

50 - 120 g

60 - 140 g

70 - 160 g

75 - 170 g

Special

90 - 190 g

130 - 290 g

Double piston system

20 - 140 g

30 - 160 g

15 - 120 g (mix row operation)

70 - 290 g (mix row operation)

Stepless adjustable.

Other weight ranges on request.

Weight ranges depending on dough consistency, as well as mixing procedures.

CAPACITY

max 9,000 pcs/hour at 6-row operation

max 7,500 pcs/hour at 5-row operation

max 6,000 pcs/hour at 4-row operation

DOUGH TYPES

For many types of dough - soft, firm, cool and sticky, e.g.

Wheat dough

Mixed wheat dough

Rye dough

Dough ring

Pretzel dough

Berliner dough

Sweet doughs

Special doughs

PRODUCTS

A wide range of excellent round, long rolled, rolled and folded as well as flat products - e.g. kaiser rolls, hot-dog buns, hamburger buns, bolillo, berliner, pretzel etc.



CLASSIC version

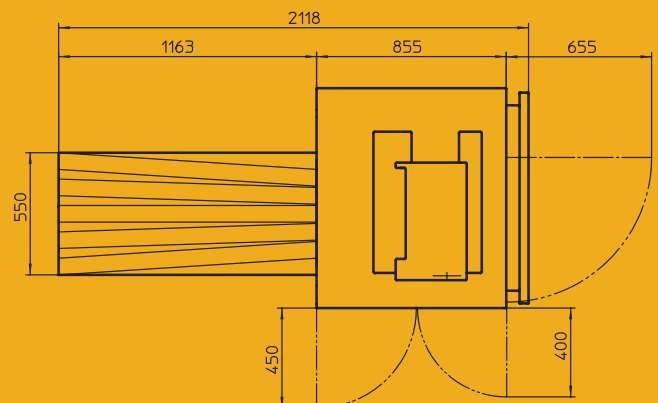
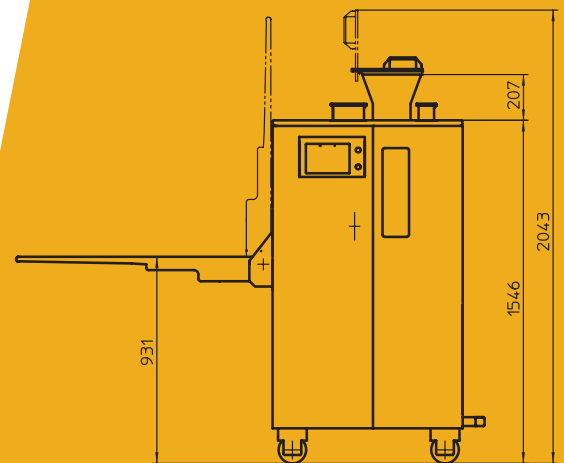
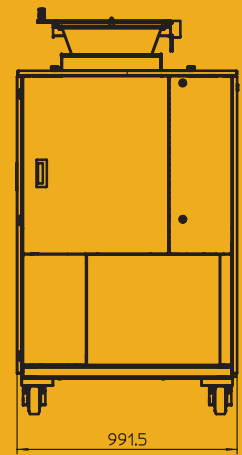

TECHNICAL SPECIFICATIONS

Machine weight	950 - 1,150 kg Depending on model and options
Voltage	380 - 415 V / 50 or 60 Hz / 3 ph+N + PE 220 - 240 V
Power	208 V 2.0 kW
Fuse	16 A

Technical specifications are subject to variation.

The baker's expertise is the inspiration for a cutting-edge divider and rounder. Gentle dough handling and precision weighin.

ALL THE SENSITIVITY OF THE BAKER'S HAND

PRIMA Evo is one of a kind, a fully automated divider and rounder that exactly simulates the precise, delicate movements of the human hand. The versatile possibilities of adaptation to most different dough qualities permit gentle treatment of the dough and high output. A special dosing system allows a gentle dough handling working method for portioning and rounding of dough pieces for the production of round pieces. The pressure of the main filling piston on the dough is compensated by a spring system. This remarkable sensitivity means it can work any type of dough, from low to high hydration, without stressing it. These characteristics – that only TRIMA can guarantee – are the result of 25 years of technological research and a journey that began in 1887. PRIMA Evo can work as a 4-row, 5-row, 6-row or 8-row divider and rounder working with weight ranges from 15 to 300 gram. All this makes PRIMA Evo an unrivalled aide in the workplace, whether it is used on its own or at the head of one of the various configurations of the Combi Line system for producing a wide range of products.

EASE OF USE, EXTRAORDINARY PERFORMANCE

PRIMA Evo produces extraordinary results from just a few, simple steps. The convenient hopper with a capacity of 25 or 40 kg feeds the dough with gentle handling thanks to feed rollers and a dosing star system into a chamber, where the dough is divided into pieces of the required weight. The pieces of dough are portioned and round in the same chamber. The dough is divided when it is put into the portioning pistons, which are adjusted of the required weight. With just three delicate movements, the pieces are cut, rounded and ejected as perfect balls. The felt wicks apply a dab of oil at each turn of the cylinder to prevent the dough from sticking – which would leave you with spoiled or deformed pieces – giving the same, optimal results every time whatever type of dough is used: soft, firm, even sticky. Convenient dials offer the option of adjusting the chamber pressure, guaranteeing perfect results across a range of weight categories. After the rounding process the dough is placed on the exit belt for manual collection or it can enter into an automatic cycle as the machine can be incorporated into an automatic production line. All adjustable machine parameters can be adjusted while processing – without stopping production.

SAFETY, PRACTICALITY AND HYGIENE

This machine is available with 2 different operating variants: manually by means of hand wheels and switches or electronically by means of a touch-screen panel and the possibility of storing the programs as a recipe and using them again. PRIMA Evo is equipped with a standard safety clutch that stops the drum automatically, if tools (e.g. knives) accidentally go into the machine, preventing serious damage.

The extremely practical, stainless-steel surfaces are hygienic and easy to clean, thanks to the wide side doors. The machine is designed to be cleaned in all its parts quickly and efficiently - the hopper, pre-divider and moulder can be swivelled out of the machine - for perfect cleaning access - it can be cleaned completely in a few minutes and does not require regular maintenance.

learn more

Find out more about using this machine as part of the Combi Line system in order to obtain a wider variety of products.



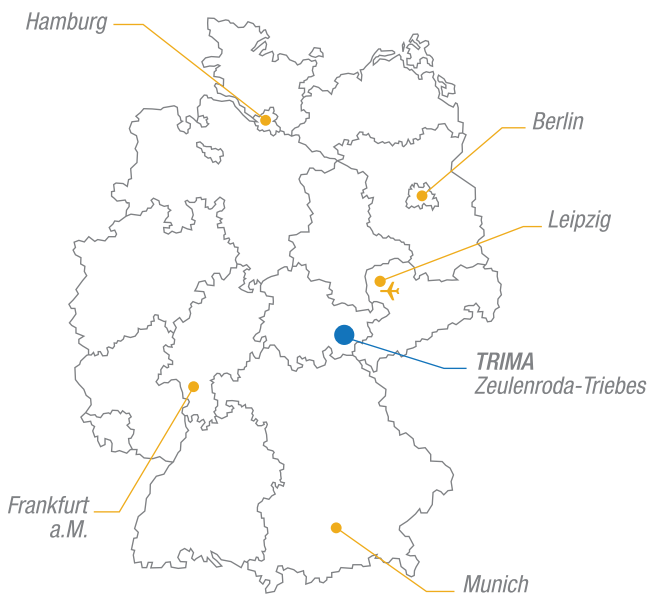

Ours is a long history of excellence and passion for working to the highest standards, our success the reward for always looking to the future, investing in research and finding innovative solutions. Since 1887, TRIMA Triebeser Maschinenbau GmbH has guaranteed reliability, precision and all the hallmarks of German technology.

TRIMA
TRY. TRUST. TRIMA.

TRIMA
Triebeser Maschinenbau GmbH
D – 07950 Zeulenroda-Triebes
Zeulenrodaer Straße 48
Tel. +49 3 66 22 / 75-0
Fax +49 3 66 22 / 75-300

www.trima.de
post@trima.de

